



**LAYFIELD**  
GEOSYNTHETICS



# FLOOD CONTROL

**WATER CONTROLLING WATER**

Step by Step Instruction Manual



# INTRO

---

Thanks for purchasing your AquaDam® the easy to use low impact alternative to sandbags. Not only will you save time, resources and money but you'll be doing your part to help minimize impact in and around the protected area.

Your AquaDam® was manufactured to the highest engineering standards and you should be able to deploy it within several hours by following the instructions and tips that are presented in this install guide.

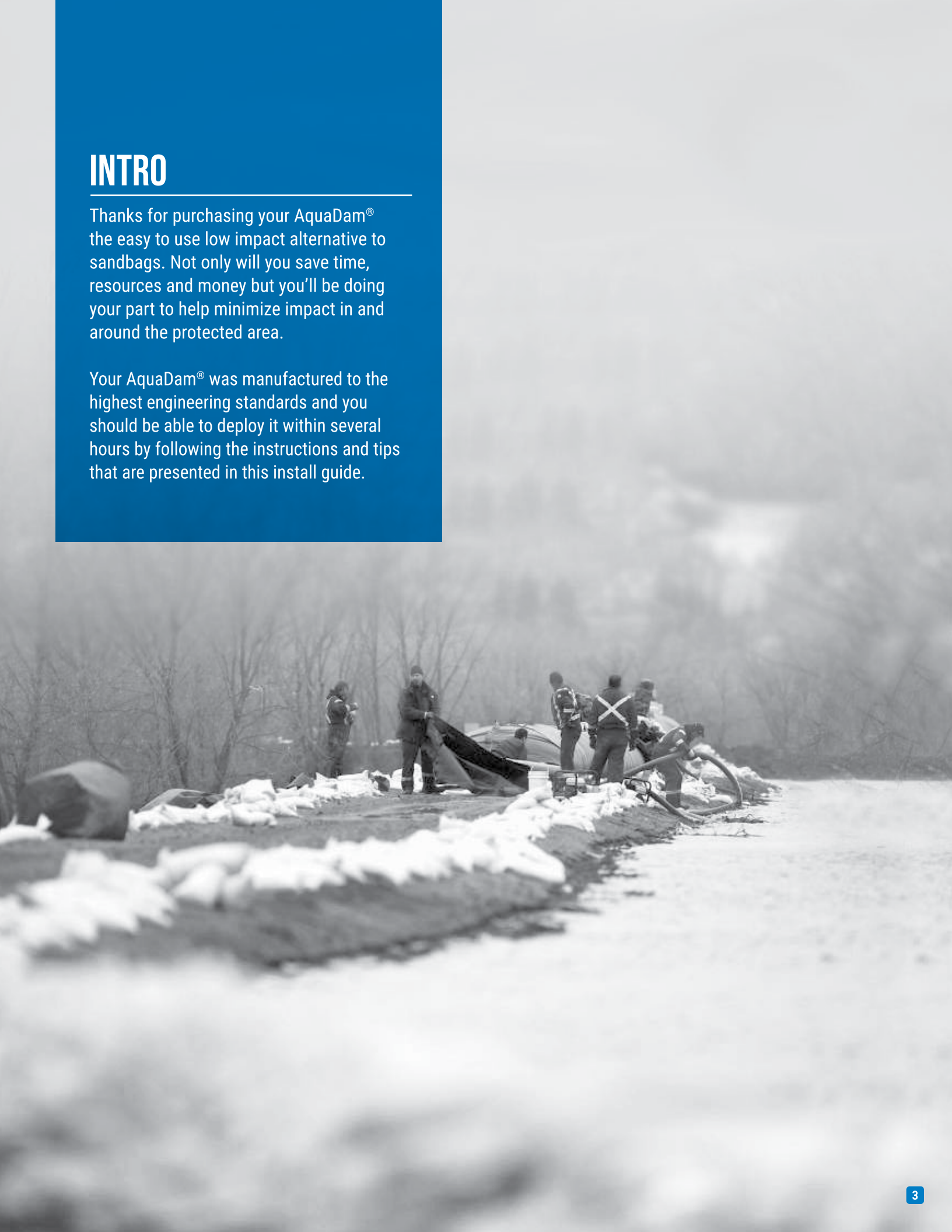



# TABLE OF CONTENTS

	Safety .....	5
	Installation procedure .....	6
	<b>STEP 1</b> - Determining height & elevation .....	7
	<b>STEP 2</b> - Transporting to site.....	8
	Self Supporting AquaDam® Overview.....	9
	<b>STEP 3</b> - Choosing your starting point.....	10
	<b>STEP 4</b> - Filling the AquaDam®.....	11
	<b>STEP 5</b> - Connecting one AquaDam® to another .....	12
	<b>STEP 6</b> - Handling and turning the AquaDam®.....	14
	<b>STEP 7</b> - Maintaining the installed AquaDam®.....	15
	Removal .....	16
	Warranty .....	18



# BEFORE WE BEGIN

## Safety

There are numerous situations where people are at work with or near water, the installation of an AquaDam® is no different and so are the inherent risks. These risks can include minor scrapes, to serious injury and/or death. Layfield highly recommends that prior to beginning the installation of an AquaDam®, an assessment of the potential risks is made, and appropriate steps are taken to mitigate these risks.

There are a number of hazards that need to be considered when working on or near water and installing an AquaDam®. These include both safety and potential health issues.

They may include, but are not limited to:

- the risk of falling into water and drowning
- contact with contaminated water
- manual handling and lifting hazards
- electrical hazards
- slips, trips and falls
- exposure to chemicals
- the effect of extreme weather
- impact with submerged objects
- floating or submerged debris, including ice
- hypothermia
- sunburn and heat stress

Please take the time to assess your particular situation and think about the risks/hazards that may exist. Look for ways to mitigate those risks prior to beginning any work when installing an AquaDam®.



# LET'S GET STARTED

These are your basic installation requirements to begin with.  
We recommend you have the following equipment and resources on hand.

- Water Source**
  - Flood water
  - Rain/Gutter runoff
  - Any running water on the ground
  - City Water
- Hose Length**

Enough suction hose to reach water from the pump location, and enough discharge (filling) hose to reach from the pump to AquaDam®.
- Roll of duct tape, utility knives and scissors**
- Two or three workers are required to install smaller AquaDam®'s**
- Two shovels**
- Wood boards for bracing against cross-slopes**
- Two 2" or 3" Cam lock connections [dependent on the product purchase]. Use either 1 pump with a "T" and valves or 2 pumps to adjust flow separately in each hose.**
- A few sandbags for shoring up minor leaks**

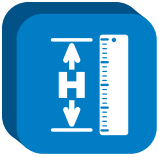

## STEP 1 Determining Height & Elevation

When the AquaDam® is at its rated height at the lowest point along its path, it is full. **DO NOT** try to overfill. The AquaDam® should always be filled and maintained to their recommended height. See chart below for recommended filling heights.

Aqua Dam Height	Max Flood Depth	Single Length	Inflated Width	Weight (lbs)
2 ft	1.5 ft	50 ft	4 ft	50 lbs
2 ft	1.5 ft	100 ft	4 ft	100 lbs
3 ft	2.3 ft	50 ft	7 ft	125 lbs
3 ft	2.3 ft	100 ft	7 ft	250 lbs
4 ft	3 ft	50 ft	10 ft	325 lbs
4 ft	3 ft	100 ft	10 ft	650 lbs

Be sure to survey and take into consideration any dips in elevation and try to maintain the max fill height associated with your AquaDam® specifications.

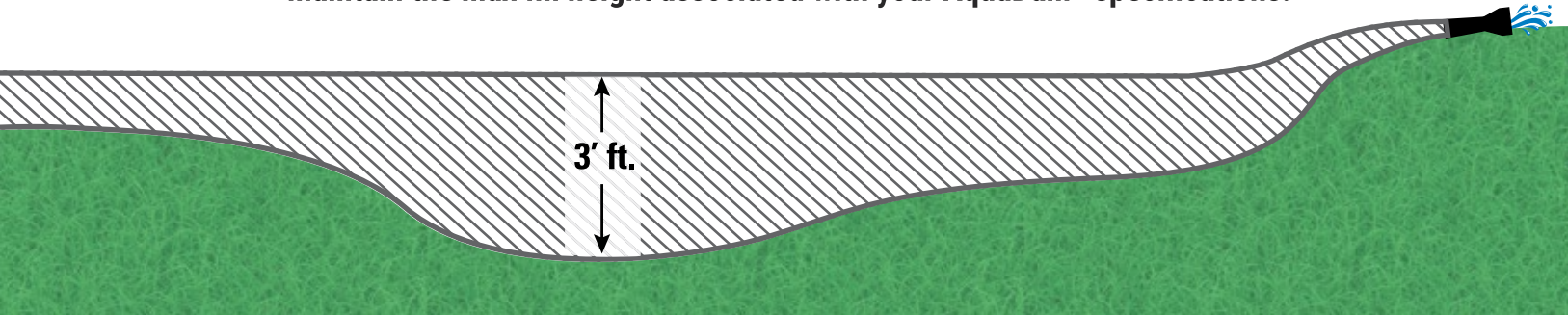



## STEP 2 Transporting to the site



### TRANSPORTING TO THE SITE

Most AquaDam® for homeowner or small business use can fit in the back of a pickup truck. Larger dams may require a trailer.

Unpack and remove any shrink-wrap or rope that may be securing the AquaDam® with scissors, CAREFULLY. Be sure not to snag or puncture the polyethylene as this would result in leaks. If the structure is to be moved by heavy equipment, secure straps around the structure then connect the straps to the heavy equipment for transportation. Use extreme caution during the transportation and installation of the AquaDam® structure. While the outer geotextile is very tough, dragging the AquaDam® during transportation, or while full or partially full, may cause damage to the geotextile and possibly the inner tube.





# Self supporting AquaDam Overview

- ✓ Place the self supporting end opposite the starting location and unroll the tube.

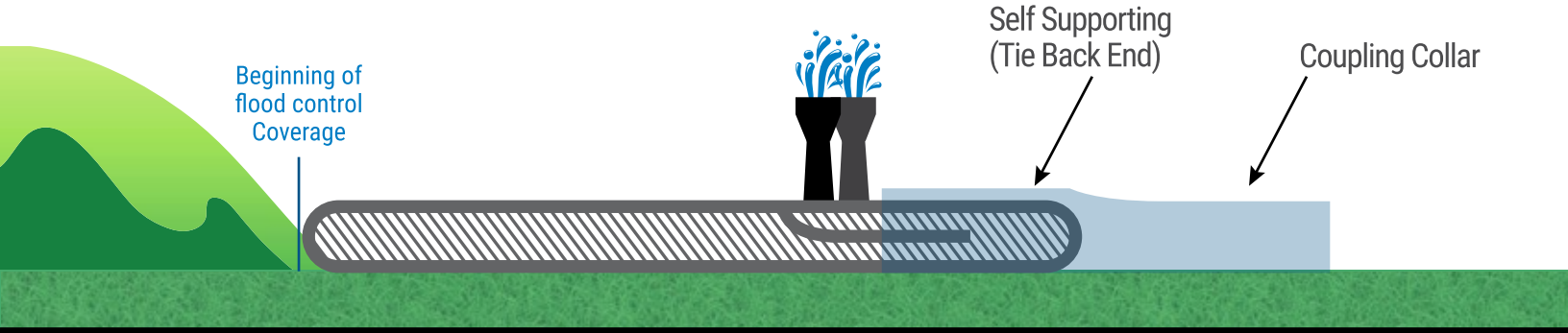

- ✓ With hoses in place, ensure a clean and secure Velcro connection. Once secured, begin filling.

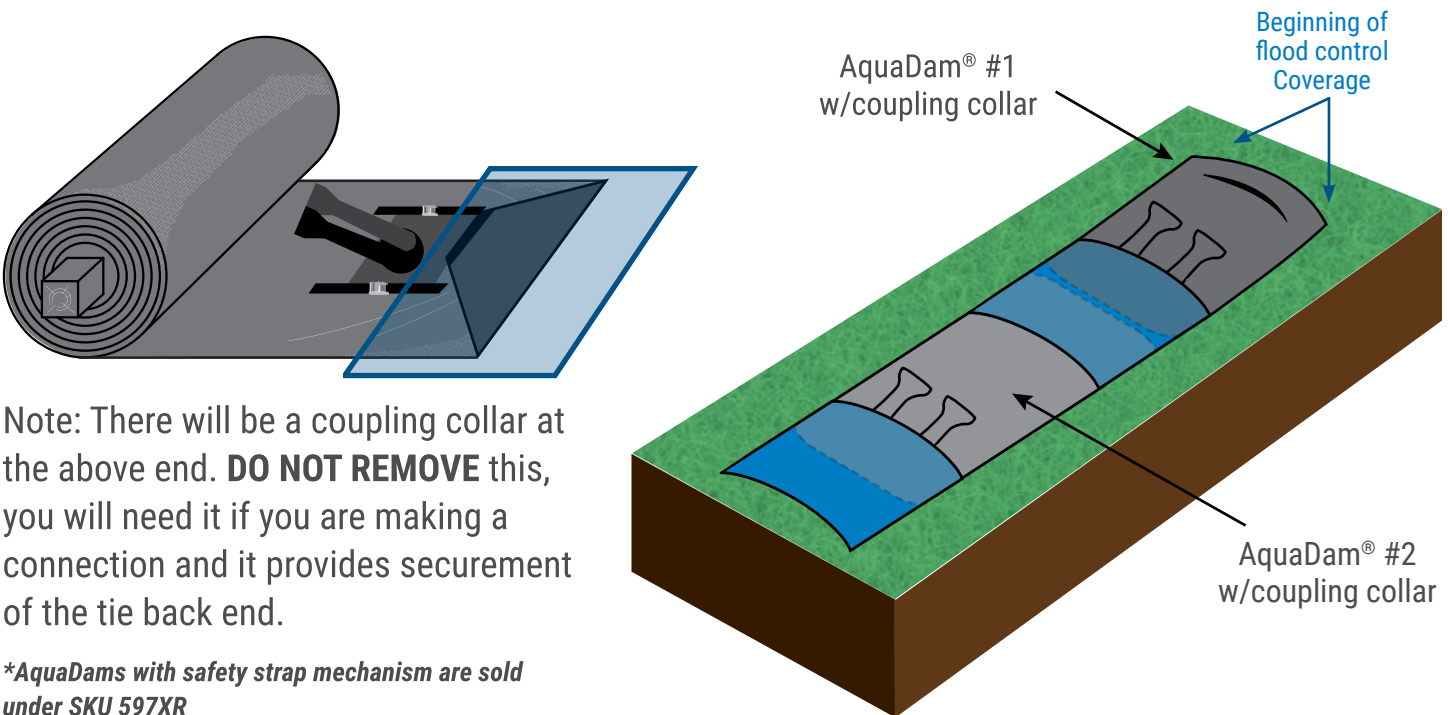
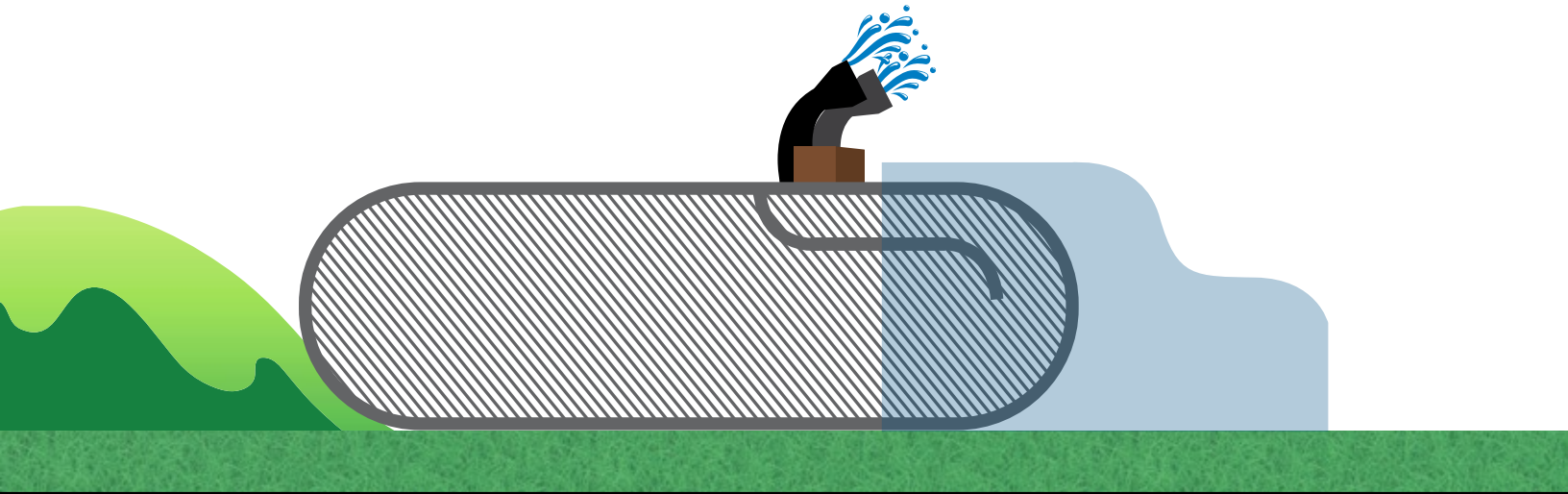

Note: There will be a coupling collar at the above end. **DO NOT REMOVE** this, you will need it if you are making a connection and it provides securement of the tie back end.

\*AquaDams with safety strap mechanism are sold under SKU 597XR

## STEP 3 Choosing your starting point



Survey the expected installation path of the AquaDam®.

**Look for low and high spots. Try to avoid low spots keeping to the level high ground.**

The AquaDam® will arrive on-site rolled up like a carpet. Place the roll along the intended footprint of the AquaDam®. Unwrap the roll, confirm orientation, and unroll the unit along the chosen path with the self supporting end opposite the starting point.

Note any slopes that run perpendicular to the installation path of the AquaDam®. These slopes may cause the AquaDam® to roll. Wooden boards should be used at these points to provide support during installation.



✓ Remove any obstructions from the path of the AquaDam®

✓ Immovable objects should be padded to minimize damage



✓ Cross-slopes should be avoided if possible but braced against if unavoidable

✓ Avoid low spots, and stay on high, level ground

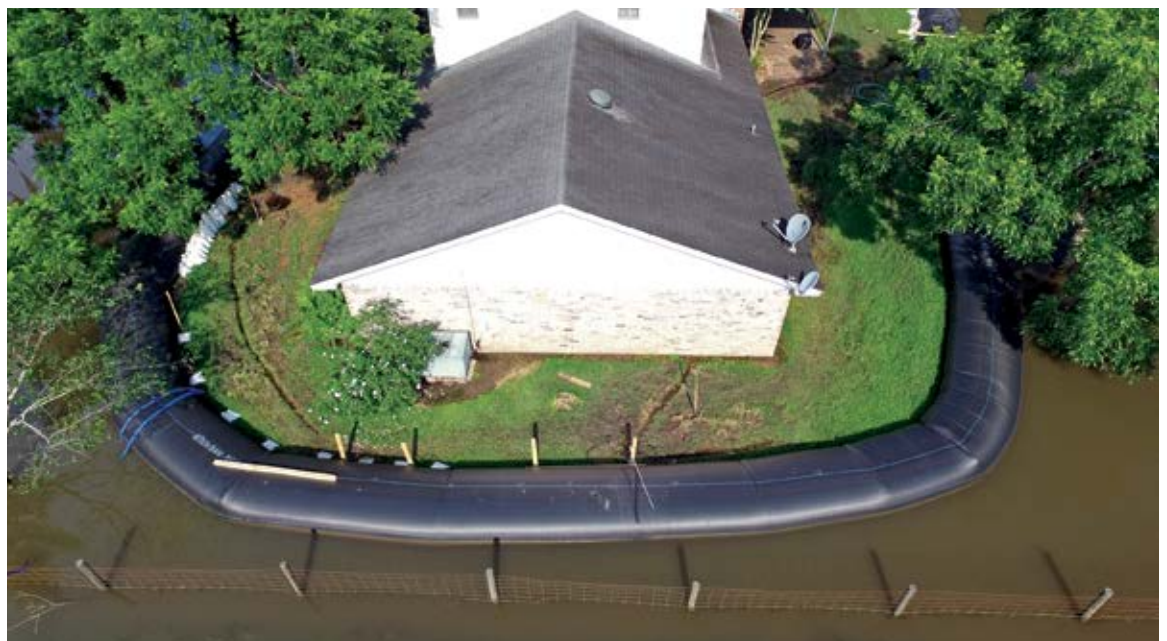



## STEP 4 Filling the AquaDam®

- ✓ Check that Velcro connections are clean and secure.
- ✓ Connect fittings to supplied hoses.
- ✓ Ensure hose is installed far enough into the fill tubes, to avoid the hose from falling out during filling.
- ✓ Add water into both inner tubes at the same time.
- ✓ Push air pockets out, so it may be expelled through the fill tubes.
- ✓ Once filled, wrap duct tape or tie rope tightly around the fill tubes to restrict the fill tube to a manageable size.
- ✓ Fold taped fill tubes back onto each other, and tape together in an upright position.
- ✓ The AquaDam® should be observed for any sideways movement. Wooden boards or other means of shoring should be used to support the AquaDam® against rolling due to cross slopes present on site.



*\*Blue color represents the black collar*





## STEP 5

## Connecting one AquaDam® to another



Here's how you connect one AquaDam® to another.

All self supporting AquaDams come with a coupling collar at the closed end.

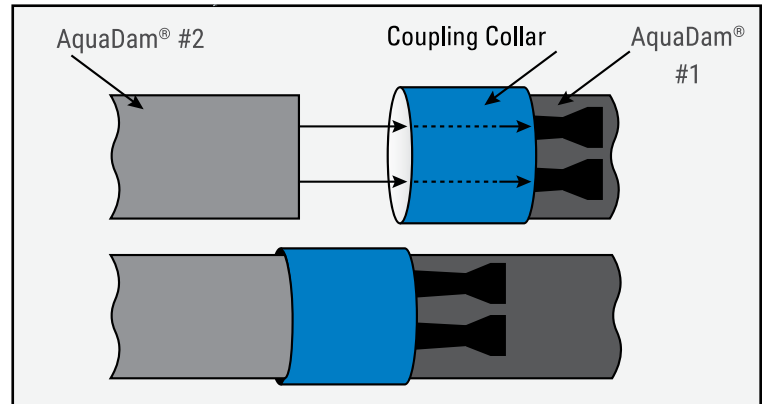

- ✓ Slide end of AquaDam® #2 into collar of AquaDam® #1.
- ✓ Allow approximately 18" - 24" of excess material against AquaDam® #1.
- ✓ Keep flat and even within the collar.
- ✓ Begin filling AquaDam® #2.



\*Blue color represents the black collar



\*Blue color represents the black collar

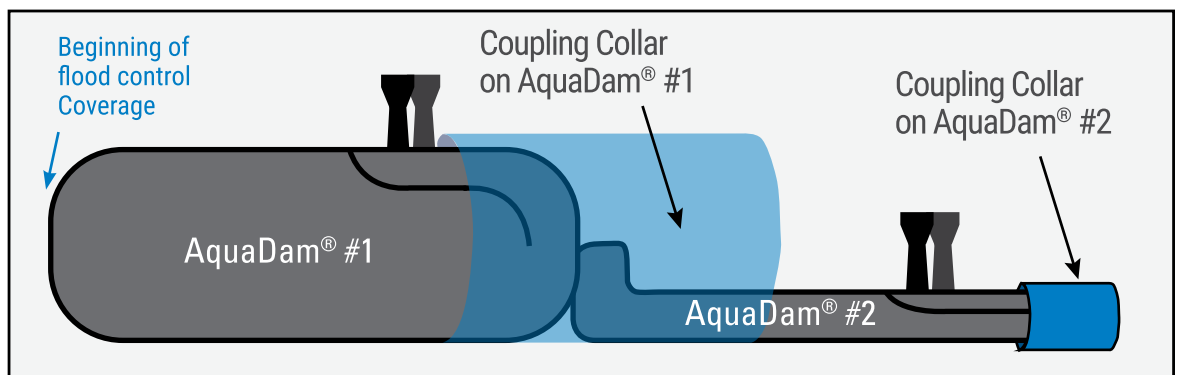



- ✓ The closed end of the AquaDam® #2 should be totally enclosed by the coupling collar. Pull the end of the outer skin of AquaDam® #2 on top of the outer skin of the water filled AquaDam® #1 within the connection collar.

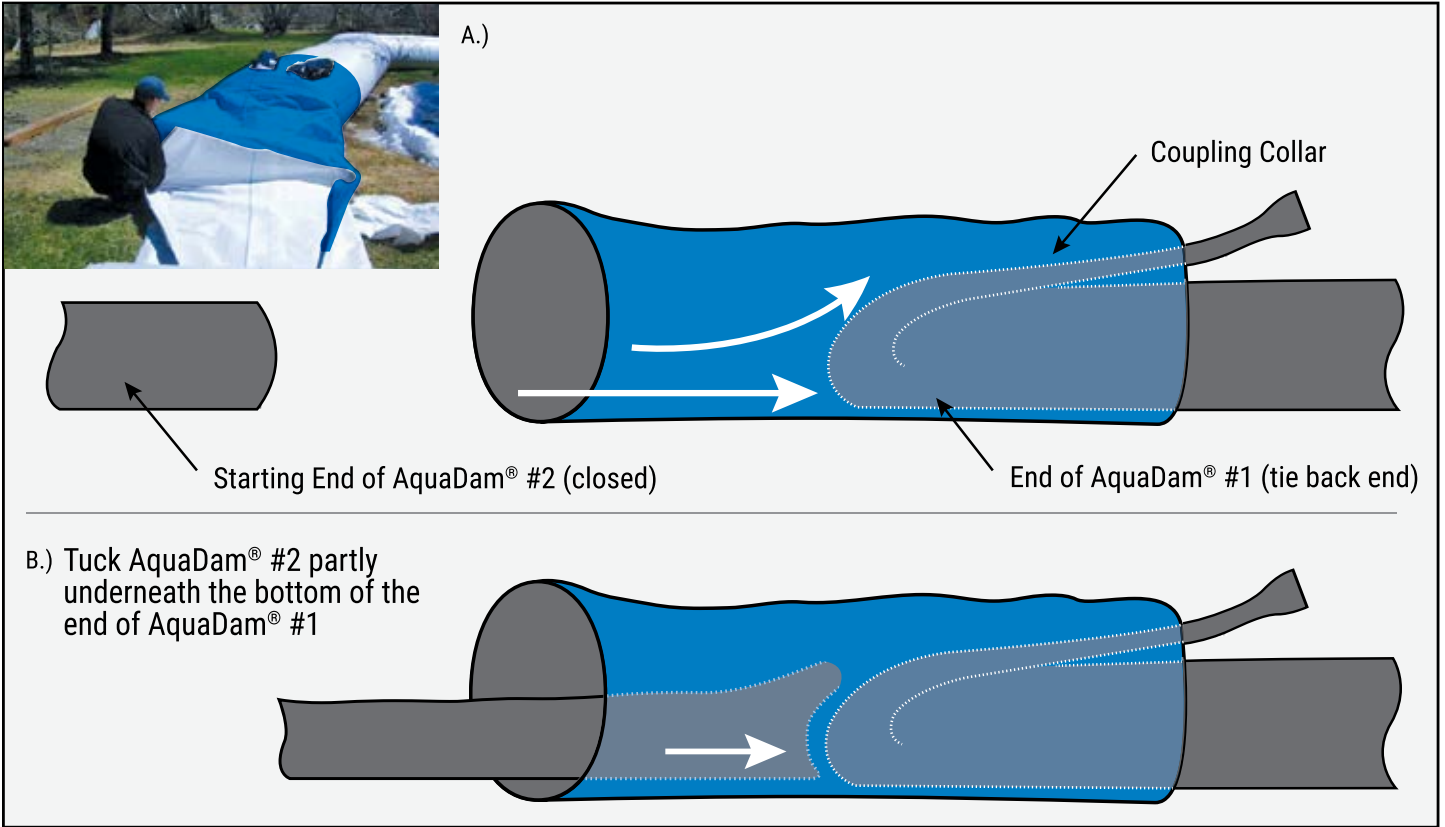

- ✓ Straighten out any wrinkles or twists in the middle of the collar.
- ✓ Connect hoses to supplied cam lock connections.
- ✓ When filling is completed, strap/tape the hoses in an upright position.

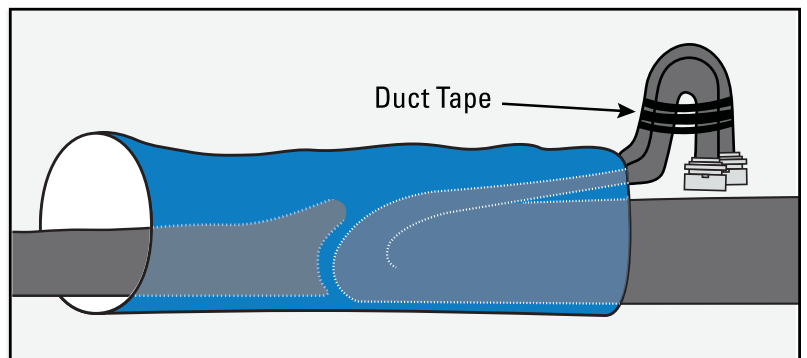

**CONNECTION IS DONE: YOU MAY COMMENCE FILLING THE AquaDam®**



## STEP 6 Handling and turning the AquaDam®

During the deployment or clean up of the AquaDam®, it's imperative to learn how to properly handle and turn the tubes in order to allow even filling/drainage of the AquaDam®.

- ✓ The AquaDam® can be unrolled and placed in its location prior to filling, or it can be unrolled while filling.
- ✓ When turning the AquaDam®, ensure a wrinkle is pulled back from the inside of the turn.

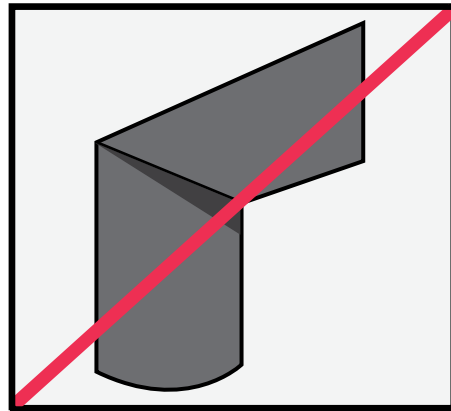
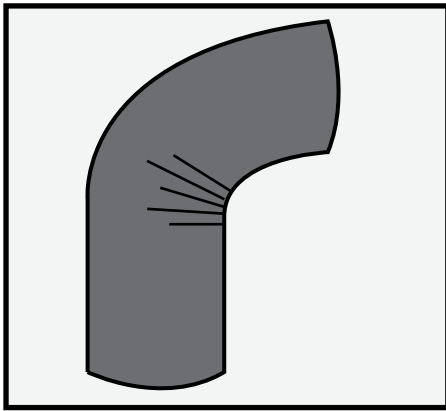

- ✓ It is most effective to create two 45° degree turns, rather than a 90° turn (where possible) to eliminate large wrinkles.

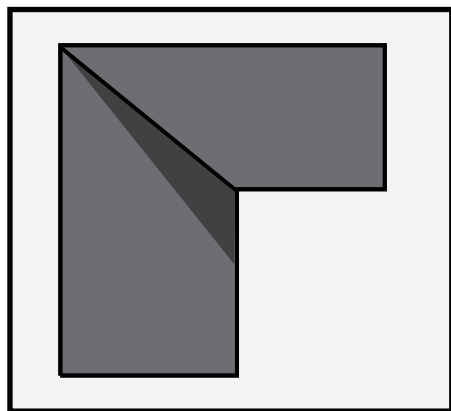
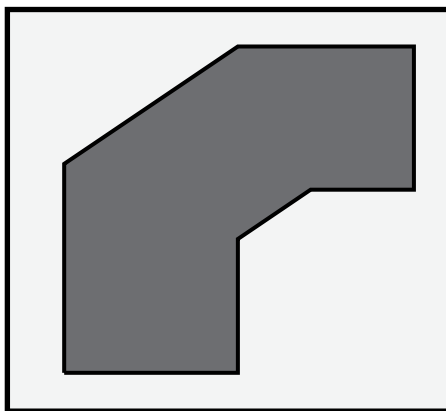

- ✓ Where possible, keep connection points away from sharper turns.
- ✓ When pulling or handling the rolled out/unfilled AquaDam®, ensure you have a hold of the exterior skin layer, as well as the internal tubing.





Your AquaDam® is durable but once the AquaDam® is in place you need to periodically inspect it to make sure it is operating at optimum efficiency.

Each installed section should be monitored regularly, at least once a day for leaks.

Gutters discharging inside of the AquaDam®'s protected area need other means to deal with the water.



### Dealing with a small leak

The easiest way to deal with a leak without removing the AquaDam® is to:

- ✓ Patch the leak with AquaDam® repair tape.  
*\*one free repair kit is provided w/the purchase of each dam*
- ✓ Periodically add water to replace any lost through damage.
- ✓ Monitor the area to ensure it does not rupture.

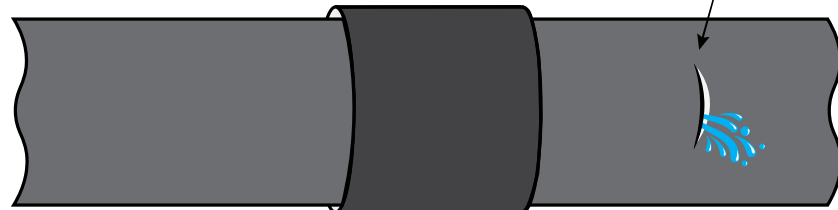

### Flood levels

- ✓ Monitor flood levels and place additional bracing behind the AquaDam® in case of increased water levels.
- ✓ If water levels approach the top of the AquaDam®, appropriate measures must be taken to make sure a failure due to over topping does not occur.

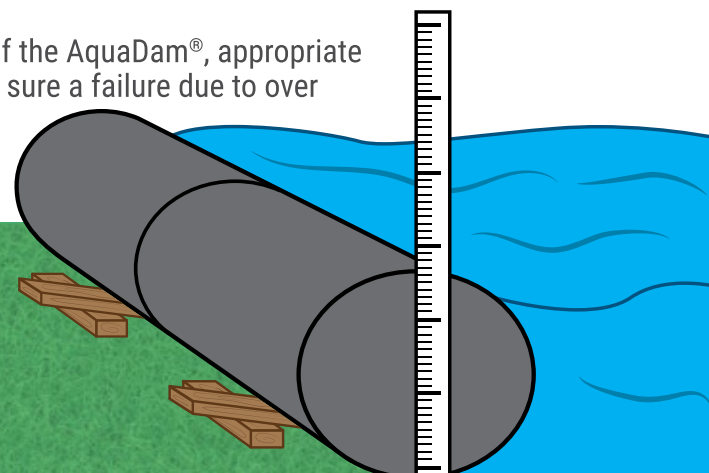



## Removal How to remove and re-roll your AquaDam®

Once you are finished with the AquaDam® it is time to release the water, and begin the re-rolling and storage process. When two or more AquaDam®'s are connected together, the downstream AquaDam® is removed first by pumping and/or siphoning out water contained within. This pump or siphon should be discharged away from any buildings to avoid accidentally causing flood damage.

On smaller AquaDam®'s, simply lift the closed end by hand.

**Any Water in the AquaDam® gets released through the large open fill tubes.**

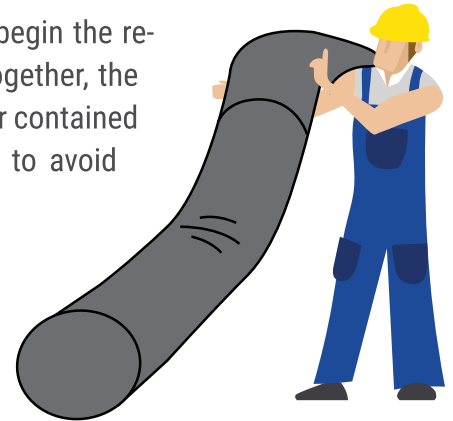

Once the AquaDam® is drained as much as possible pull the open end to a low position.

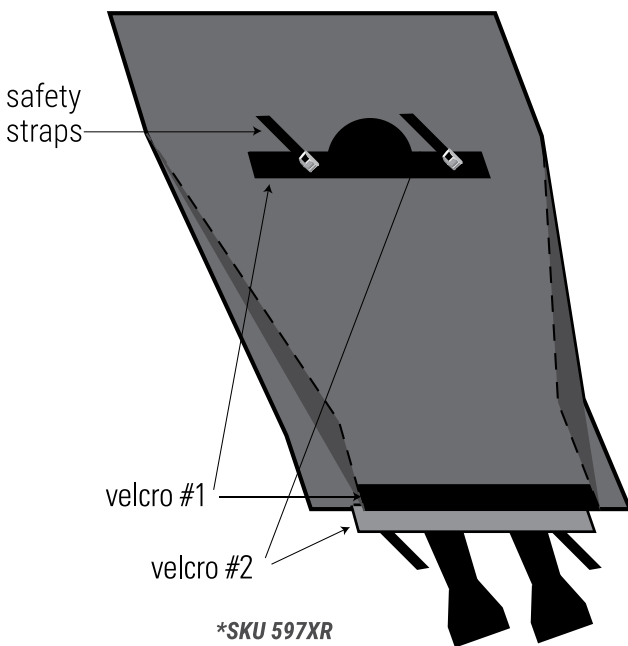

### Double Closed Ended AquaDam®

- ✓ Remove tape from fill tubes
- ✓ Disconnect safety straps
- ✓ Disconnect velcro
- ✓ Allow fill tube to release through the collar and empty the AquaDam®
- ✓ Remove collar
- ✓ Remove residual water starting at closed end, lift and work towards the open end
- ✓ Flatten the poly tubes to ensure there isn't any twisting
- ✓ Fold the end of the AquaDam back and fasten Velcro #1 to Velcro #1
- ✓ Bunch tubing together and insert into the hole located on the flap, do not twist the tubing material
- ✓ Fasten Velcro #2 to Velcro #2
- ✓ Install the collar over the folded system up to the location of the Velcro
- ✓ Ensure the AquaDam is flat within the collar
- ✓ Flatten and Roll

### Folded AquaDam®

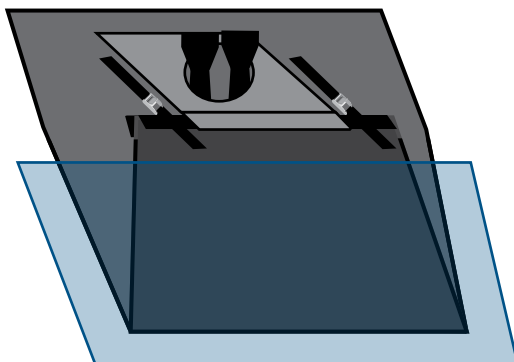

Re-rolling brackets can be purchased by contacting your local LAYFIELD dealer

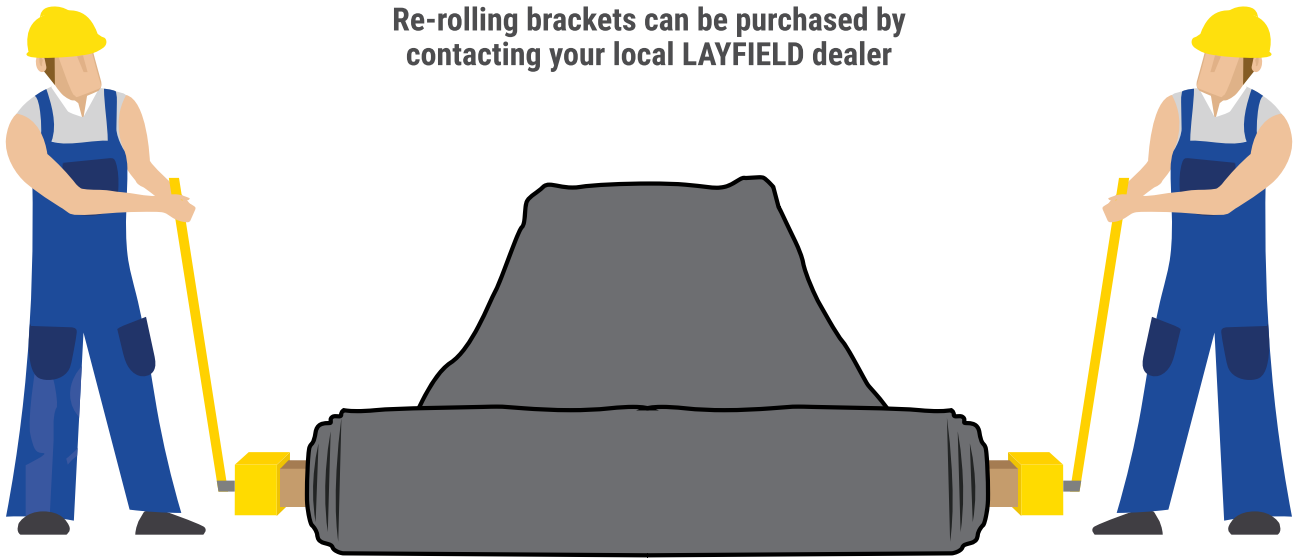

The AquaDam® is **heavy**, please take steps to avoid over exertion!

**When the beam is firmly seated against the closed end of the AquaDam®, it can be rolled up.**

Connect the re-rolling brackets to either side of the beam with associated ratchets and cheater pipes.

The first few rolls of the AquaDam® around the beam may need a person to help the roll go around once the beam is firmly seated against the closed end of the AquaDam®. One person on each of the two ratchets with cheater pipes can roll up the AquaDam®. Water contained within the AquaDam® gets rolled out through the large open fill tubes.

To view a video detailing how to “Re-roll using brackets” go to: [www.youtube.com/@layfieldgroup7131](http://www.youtube.com/@layfieldgroup7131)



**Properly store your AquaDam®**

- Off the ground
- Keep away from sunlight
- Keep away from rodents

A properly stored AquaDam® will last for several seasons in storage.

**Again THANK YOU for purchasing your AquaDam®. We know it'll serve you well.**





## WARRANTY

Layfield warrants to Buyer of the Products manufactured or supplied by Layfield that the Products will be free from defects in material and workmanship under normal and proper usage for a period of one (1) year from the date of shipment of the Products from Layfield. The foregoing warranty will not cover and Layfield makes no warranties with respect to:

- (a) Any Products subject to abuse, misuse, misapplication, neglect, alteration or accident, to improper and incorrect installation or maintenance, or to abnormal conditions of use, temperature, moisture, dirt, or corrosive material; or
- (b) Materials, parts, goods or other components that are manufactured by someone other than Layfield.

The foregoing warranty is exclusive and in lieu of all other warranties, whether expressed or implied, or otherwise arising by operation of law, trade, usage or course of dealing, including without limitation, the implied warranties of merchantability and fitness for particular purpose.

**Notice of Breach:** Buyer agrees to provide Layfield with written notice of any breach of the above warranty within thirty (30) days after Buyer discovers, or should have discovered, the alleged breach. Time is of the essence herein and Buyer's failure to provide written notice to Layfield within the required time of any alleged breach of the foregoing warranty will release and discharge Layfield from any obligation or liability for the breach of warranty.

Layfield reserves the right to examine the Products after receipt of written notice from the Buyer of a claim under this warranty. On request, Layfield, or a representative or agent chosen by Layfield, will be provided access by the Buyer to the Products for examination within thirty (30) days immediately following receipt of written notice from the Buyer of the alleged breach. The Buyer will make all efforts to facilitate such examination by Layfield on a timely basis.

If required by Layfield, the Products alleged to be defective will be returned to Layfield, at its sole discretion and expense, for examination. No goods are to be returned to Layfield without its prior written authorization.

**Limitations on Remedies:** In the event of a material breach of the above warranty and provided that Buyer gave written notice of the alleged breach within the time required, Layfield will, in its sole discretion, refund Buyer the purchase price of the defective Products purchased by the Buyer or repair or replace the defective Products. The remedies set forth herein shall be the sole and exclusive remedies available to Buyer so that Layfield's payment of the purchase price of the defective Products to the Buyer or repair or replacement of the defective Products is a fulfillment of all of Layfield's obligations. Layfield shall not be liable for special, incidental, or consequential damages for, resulting from, or in connection with, any breach of warranty or for any loss, injury, or damage of any kind to property or person resulting from the use of the Products by the Buyer. Under no circumstances shall Layfield be liable for damages beyond the purchase price of the defective Products purchased by the Buyer, whether in contract, in tort, or under any warranty or other use. Without limiting the generality of the foregoing, Layfield shall not be responsible for water damage caused by or related to a failure of the Products, or for mold, mildew, fungi, or air quality problems related thereto.





For more information on AquaDam® water management products,  
Please contact your local Layfield representative



(800) 840-2884 Canada  
(800) 796-6868 United States  
[www.AquaDam.ca](http://www.AquaDam.ca)

